

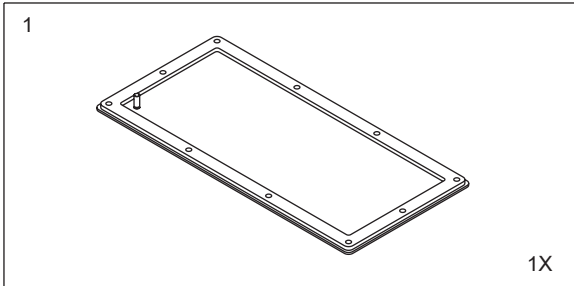

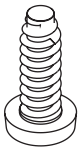



② 25 ± 8 in-lb
2.82 ± .9 N-M

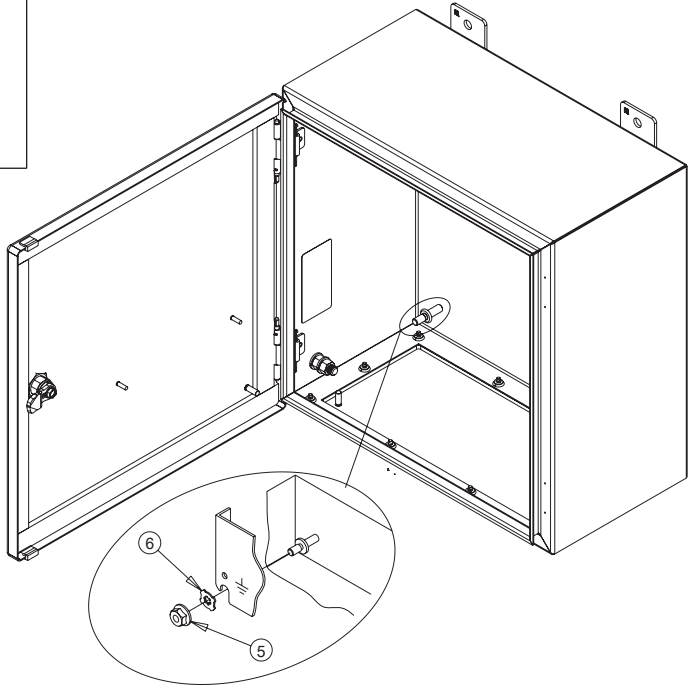
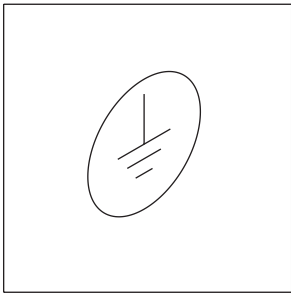

<p>2</p> <p>M4.8-1.6 X16mm</p>  <p>6X 14X</p>	<p>3</p> <p>.19 X.44 X.031</p>  <p>6X 14X</p>	<p>4</p> <p>.38 X.16 X.026</p>  <p>6X 14X</p>
--	--	--

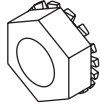
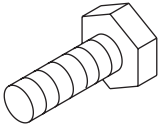

<p>5</p>  <p>4X 8X</p>	<p>6</p>  <p>1X</p>	<p>7</p>  <p>6X</p>
<p>8</p>  <p>2X</p>	<p>9</p>  <p>2X</p>	

